

**JUMO GmbH & Co. KG**  
 Delivery address: Mackenrodtstraße 14  
 36039 Fulda, Germany  
 Postal address: 36035 Fulda, Germany  
 Phone: +49 661 6003-0  
 Fax: +49 661 6003-607  
 E-mail: mail@jumo.net  
 Internet: www.jumo.net

**JUMO Instrument Co. Ltd.**  
 JUMO House  
 Temple Bank, Riverway  
 Harlow, Essex CM20 2DY, UK  
 Phone: +44 1279 635533  
 Fax: +44 1279 635262  
 E-mail: sales@jumo.co.uk  
 Internet: www.jumo.co.uk

**JUMO Process Control, Inc.**  
 6733 Myers Road  
 East Syracuse, NY 13057, USA  
 Phone: 315-437-5866  
 1-800-554-5866  
 Fax: 315-437-5860  
 E-mail: info.us@jumo.net  
 Internet: www.jumousa.com



# JUMO Quantrol LC100/LC200/LC300

## Universal PID Controller Series

### Brief description

The Quantrol series is available in the three DIN formats 48 mm x 48 mm, 48 mm x 96 mm, and 96 mm x 96 mm. It is used for two-state and three-state control applications as well as for the control of regulating valves or SCR power controllers via a continuous controller output.

The universal analog input for RTD temperature probes, thermocouples, or current/voltage signals is user programmable. The setpoint value, the actual value, and all parameters are displayed on two seven-segment LED displays (red/green) with one or two decimal place(s). The values can be displayed in °C or °F. Depending on the format, up to five relay outputs with a switching capacity of 3 A / 230 V or up to four logic outputs 0/14 V are available. The switch position of the relays or logic outputs is displayed using yellow LEDs. Different functions can be assigned to these outputs. An analog output 0 to 10 V or 0(4) to 20 mA is configurable as continuous controller output, actual value output, or setpoint value output. Using the binary input, the device settings and operation can be locked, a ramp or the timer can be activated, or self-optimization can be initiated. The supply voltage is optionally AC 110 to 240 V or AC/DC 20 to 30 V.

The controller has a ramp function with adjustable gradient for constant setpoint change. In addition, a special firing curve for small pottery kilns can be used which allows controlled starting and time dependent firing. The user can enter setpoint values, gradient, and firing time directly at the device.

The device can be connected to host systems or devices using the RS485 serial interface. Instead of operating the device from the front, the user can also program the controller using the setup program and USB interface; this requires no additional voltage supply for the controller. The Quantrol series, like all JUMO controllers, is also equipped with reliable JUMO self-optimization (autotuning).



LC100 (702031)



LC200 (702032)



LC300 (702034)

### Block diagram

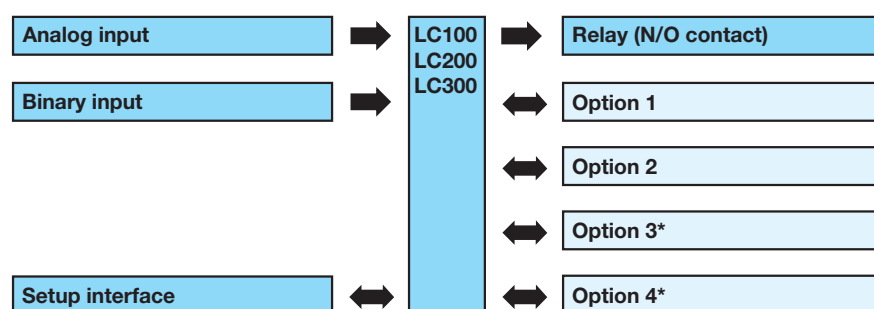

\* Option for LC200/LC300

Options are delivered ex-factory acc. to the order details.

Option 1	Option 2	Option 3	Option 4	
X	X	X	X	Relay output (N/O contact)
X	X	X	X	Logic output
X				Analog output
	X			RS485 interface

### Special features

- 48 × 48, 48 × 96, 96 × 96 mm formats
- Two-state/three-state and continuous controller
- Sensor monitoring
- Up to 5 outputs
- Self-optimization (autotuning) for exact PID control
- Manual/automatic mode
- Configurable limit value monitoring (alarms)
- Setpoint changeover
- Level inhibit and key lock
- RS485 interface (Modbus RTU)
- Ramp and timer function
- Firing curve for pottery kilns
- Push-in controller insert
- Setup interface (USB Mini-B)

### Approvals/approval marks (see "Technical data")

**JUMO GmbH & Co. KG**

Delivery address: Mackenrodtstraße 14  
36039 Fulda, Germany  
Postal address: 36035 Fulda, Germany  
Phone: +49 661 6003-0  
Fax: +49 661 6003-607  
E-mail: mail@jumo.net  
Internet: www.jumo.net

**JUMO Instrument Co. Ltd.**

JUMO House  
Temple Bank, Riverway  
Harlow, Essex CM20 2DY, UK  
Phone: +44 1279 635533  
Fax: +44 1279 635262  
E-mail: sales@jumo.co.uk  
Internet: www.jumo.co.uk

**JUMO Process Control, Inc.**

6733 Myers Road  
East Syracuse, NY 13057, USA  
Phone: 315-437-5866  
1-800-554-5866  
Fax: 315-437-5860  
E-mail: info.us@jumo.net  
Internet: www.jumousa.com



## Description

### Self-optimization (autotuning)

Standard features include the tried and tested self-optimization (oscillation method), which makes it possible for the controller to be matched to the control loop by a user who is not a control technology expert. Here, the reaction of the control path to the specific variable changes is evaluated and the controller parameters proportional band, reset time, derivative time, cycle time, and filter time constant are calculated.

### Ramp function

The ramp function is used for a constant change of setpoint value  $w$  up to the ramp limit value  $SP$  (entered setpoint value). A rising or a falling edge arises depending on the actual value at the time of ramp start  $t_0$ . The slope is defined by a gradient which is entered during the controller configuration.

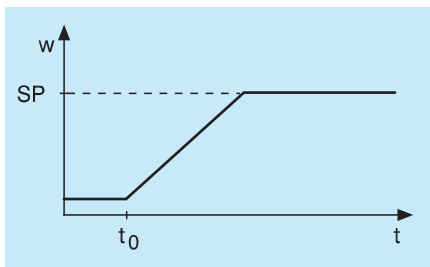

### Timer

The timer is started manually or automatically (after power on, for example). When the timer expires, the timer output signal changes its state (configurable). The timer can be used to implement functions like time-limited control or setpoint changeover.

### Setup program

The setup program provides the user with an easy and comfortable way to configure the controller using a PC.

The PC has to be connected to the controllers USB interface (Mini-B type) with a USB cable. Thereby the controller is powered over the USB interface. As a result, no mains supply is required during the configuration.

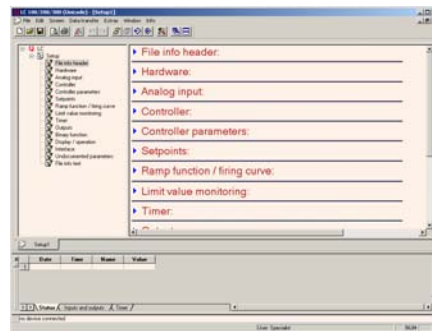

### Firing curve

The firing curve is used for controlled starting and time-dependent firing of small pottery kilns. The user can enter setpoint values, gradient, and firing time directly at the device.

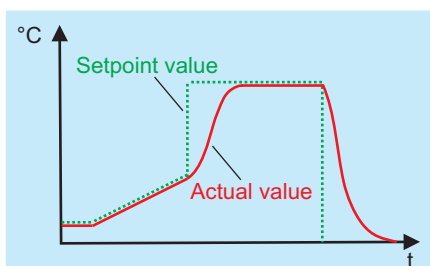

### Limit value monitoring

The controller is equipped with two limit value monitoring functions, each with eight configurable alarm functions. Any analog signals can be selected as actual and setpoint value from a selector. When a limit value is exceeded, a signal can be displayed or an internal controller function initiated. With the limit value monitoring, extensive alarm and limit value functions can be implemented.

**JUMO GmbH & Co. KG**  
 Delivery address: Mackenrodtstraße 14  
 36039 Fulda, Germany  
 Postal address: 36035 Fulda, Germany  
 Phone: +49 661 6003-0  
 Fax: +49 661 6003-607  
 E-mail: mail@jumo.net  
 Internet: www.jumo.net

**JUMO Instrument Co. Ltd.**  
 JUMO House  
 Temple Bank, Riverway  
 Harlow, Essex CM20 2DY, UK  
 Phone: +44 1279 635533  
 Fax: +44 1279 635262  
 E-mail: sales@jumo.co.uk  
 Internet: www.jumo.co.uk

**JUMO Process Control, Inc.**  
 6733 Myers Road  
 East Syracuse, NY 13057, USA  
 Phone: 315-437-5866  
 1-800-554-5866  
 Fax: 315-437-5860  
 E-mail: info.us@jumo.net  
 Internet: www.jumousa.com



## Controller parameters

All the parameters and their meanings are included in the table. Some parameters may be missing or meaningless for a particular type of controller.

Parameters	Value range	Factory setting	Meaning
Proportional band 1 (Pb1)	0 to 9999 digit	0 digit	Size of the proportional band
Proportional band 2 (Pb2)	0 to 9999 digit	0 digit	The controller structure is not effective with Pb = 0 (behavior identical to limit value monitoring). For a continuous controller, Pb1 must be > 0.
Derivative time (dt)	0 to 9999 s	80 s	Influences the differential component of the controller output signal
Reset time (rt)	0 to 9999 s	350 s	Influences the integral component of the controller output signal
Cycle time 1 (Cy1)	0 to 999.9 s	20.0 s	When using a switched output, the cycle time should be chosen so that the energy supply to the process is as continuous as possible without overloading the switching elements.
Cycle time 2 (Cy2)	0.0 to 999.9 s	20.0 sec	
Contact spacing (db)	0.0 to 999.9 digit	0.0 digit	Spacing between the two control contacts of the three-state controller
Switching differential 1 (Hys1)	0.0 to 999.9 digit	1.0 digit	Switching differential of a switching controller with proportional band Pb = 0 (behavior identical to limit value monitoring)
Switching differential 2 (Hys2)	0.0 to 999.9 digit	1.0 digit	
Working point (y0)	-100 to +100 %	0 %	Output level for P and PD controller (if x = w then y = y0)
Output value limit 1 (y1)	0 to 100 %	100 %	Maximum output value limit (only effective if Pb > 0)
Output value limit 2 (y2)	-100 to +100 %	-100 %	Minimum output value limit (only effective if Pb > 0)

## Technical data

### Thermocouple input

Description	Standard	Measuring range <sup>a</sup>	Measuring accuracy <sup>b</sup>	Ambient temperature influence
Fe-CuNi "L"		-150 to +900 °C	≤ 0.4 %	≤ 100 ppm/K
Fe-CuNi "J"	EN 60584	-200 to +1200 °C	≤ 0.4 %	≤ 100 ppm/K
Cu-CuNi "T"	EN 60584	-200 to +400 °C	≤ 0.4 %	≤ 100 ppm/K
NiCr-Ni "K"	EN 60584	-200 to +1372 °C	≤ 0.4 %	≤ 100 ppm/K
NiCr-CuNi "E"	EN 60584	-200 to +1000 °C	≤ 0.4 %	≤ 100 ppm/K
NiCrSi-NiSi "N"	EN 60584	-100 to +1300 °C	≤ 0.4 %	≤ 100 ppm/K
Pt10Rh-Pt "S"	EN 60584	-40 to +1768 °C	≤ 0.4 %	≤ 100 ppm/K
Pt13Rh-Pt "R"	EN 60584	-40 to +1768 °C	≤ 0.4 %	≤ 100 ppm/K

Cold junction: KTY internal

<sup>a</sup> This information refers to the ambient temperature of 20 °C.

<sup>b</sup> Incl. measuring accuracy at the cold junction.  
 The accuracy values refer to the measuring range.

### RTD temperature probe input

Designation, Connection type	Measuring range	Measuring accuracy <sup>a</sup>	Ambient temperature influence
Pt100 EN 60751 2-wire connection 3-wire connection	-200 to +650 °C	≤ 0.4 % ≤ 0.4 %	≤ 50 ppm/K
Pt1000 EN 60751 2-wire connection 3-wire connection	-200 to +650 °C	≤ 0.4 % ≤ 0.4 %	≤ 50 ppm/K
KTY, R <sub>25</sub> = 1000 Ω 2-wire connection	-50 to +150 °C	≤ 1.0 %	≤ 50 ppm/K
KTY, R <sub>25</sub> = 2000 Ω 2-wire connection	-50 to +80 °C	≤ 1.0 %	≤ 50 ppm/K
Cu-50 3-wire connection	-50 to +200 °C	≤ 1.0 %	≤ 50 ppm/K

**JUMO GmbH & Co. KG**  
 Delivery address: Mackenrodtstraße 14  
 36039 Fulda, Germany  
 Postal address: 36035 Fulda, Germany  
 Phone: +49 661 6003-0  
 Fax: +49 661 6003-607  
 E-mail: mail@jumo.net  
 Internet: www.jumo.net

**JUMO Instrument Co. Ltd.**  
 JUMO House  
 Temple Bank, Riverway  
 Harlow, Essex CM20 2DY, UK  
 Phone: +44 1279 635533  
 Fax: +44 1279 635262  
 E-mail: sales@jumo.co.uk  
 Internet: www.jumo.co.uk

**JUMO Process Control, Inc.**  
 6733 Myers Road  
 East Syracuse, NY 13057, USA  
 Phone: 315-437-5866  
 1-800-554-5866  
 Fax: 315-437-5860  
 E-mail: info.us@jumo.net  
 Internet: www.jumousa.com



Designation, Connection type	Measuring range	Measuring accuracy <sup>a</sup>	Ambient temperature influence
Probe wire resistance: max. 30 Ω per wire with 3-wire circuit			
Measuring current: Pt100 approx. 1 mA; Pt1000 and KTY approx. 100 μA			
Lead compensation: not required for 3-wire circuit. For a 2-wire circuit, the lead resistance can be compensated by correcting the actual value.			

<sup>a</sup> The accuracy values refer to the measuring range.

### Input for standard signals

Measuring range	Measuring accuracy <sup>a</sup>	Ambient temperature influence
Voltage 0 to 10 V Input resistance > 650 kΩ	≤ 0.4 %	≤ 150 ppm/K
Current 0(4) to 20 mA Voltage drop > 2.2 V	≤ 0.4 %	≤ 100 ppm/K

<sup>a</sup> The accuracy values refer to the maximum measuring range.

### Binary input

Input for potential-free contact	Open = inactive; Closed = active
----------------------------------	-------------------------------------

### Measuring circuit monitoring

In the event of a malfunction, the outputs move to a defined (configurable) status.

Measuring probe	Overrange /underrange	Probe/ cable short circuit	Probe/ cable break
Thermocouple	•	-	•
Resistance thermometer	•	•	•
Voltage 0 to 10V	-	-	-
Current 4 to 20 mA	•	•	•
Current 0 to 20 mA	-	-	-

• = detected    - = not detected

### Outputs

Relay (N/O contact) Contact rating Contact life	Max. 3 A at 230 V AC resistive load 150,000 operations at nominal load 350,000 operations at 1 310,000 operations at 1 A and $\cos\varphi > 0.7$
Logic output	0/14V / 20mA max.
Voltage (option) Output signal Load resistance Accuracy	0 to 10V > 600 Ω < 0.5 %
Current (option) Output signals Load resistance Accuracy	0 to 20 mA / 4 to 20 mA < 450 Ω < 0.5 %

**JUMO GmbH & Co. KG**  
 Delivery address: Mackenrodtstraße 14  
 36039 Fulda, Germany  
 Postal address: 36035 Fulda, Germany  
 Phone: +49 661 6003-0  
 Fax: +49 661 6003-607  
 E-mail: mail@jumo.net  
 Internet: www.jumo.net

**JUMO Instrument Co. Ltd.**  
 JUMO House  
 Temple Bank, Riverway  
 Harlow, Essex CM20 2DY, UK  
 Phone: +44 1279 635533  
 Fax: +44 1279 635262  
 E-mail: sales@jumo.co.uk  
 Internet: www.jumo.co.uk

**JUMO Process Control, Inc.**  
 6733 Myers Road  
 East Syracuse, NY 13057, USA  
 Phone: 315-437-5866  
 1-800-554-5866  
 Fax: 315-437-5860  
 E-mail: info.us@jumo.net  
 Internet: www.jumousa.com



## Controller

Controller type	Two-state controller, three-state controller, continuous controller
Controller structures	P/PI/PD/PID
Sampling rate	250 ms
A/D converter	16-bit resolution

## Timer

Accuracy	0.8 % ± 10 ppm/K ± 250 ms
----------	---------------------------

## Electrical data

Voltage supply (switch mode PSU)	AC 110 to 240V +10/-15 %, 48 to 63Hz AC/DC 20 to 30V, 48 to 63Hz
Electrical Security	Acc. to DIN EN 61010, part 1 Overvoltage category III, pollution degree 2
Power consumption	Max. 14 VA
Electrical connection Conductor cross section Tightening torque	On the rear via screw terminals; with core-end ferrule of a pipe shape, open cable lug or pin cable lug Fine-strand 0.25 to 1.5 mm <sup>2</sup> 0.5 Nm
Electromagnetic compatibility Interference emission Interference immunity	Acc. to DIN EN 61326-1 Class A - only for industrial use - Industrial requirements
Setup interface	USB socket, type Mini-B 5-pole

## Requirements for core-end ferrules and cable lugs

Core-end ferrule	Pipe shape, without plastic sheath acc. to DIN 46228 part 1, with plastic sheath acc. to DIN 46228 part 4
Cable lug	Open crimp cable lug, dimensionally adapted to DIN 46237 for closed crimp cable lugs
Pin cable lug	Acc. to DIN 46231
For UL applications	Use of the cable lugs or ferrules acc. to UL 486A-B (UL listed or recognized)

## Case and ambient conditions

Case type	Plastic case for panel mounting acc. to IEC 61554 (indoor use)
Dimensions (front)	LC100: 48 mm x 48 mm; LC200: 48 mm x 96 mm (portrait format); LC300: 96 mm x 96 mm
Weight (fully fitted)	LC100: approx. 150 g; LC200: approx. 200 g; LC300: approx. 300 g
Protection class	Acc. to DIN EN 60529, at the front IP 65, at the rear IP 20
Operating position	Any
Panel cut-out	LC100: 45 mm x 45 mm; LC200: 45 mm x 92 mm; LC300: 92 mm x 92 mm
Minimum spacing horizontal / vertical	LC100: 11 mm / 30 mm (65 mm with USB cable); LC200/LC300: 22 mm / 30 mm (65 mm with USB cable)
Depth behind panel	LC100: max. 95 mm; LC200/LC300: max. 80 mm
Ambient/storage temperature range	-5 to +55 °C / -40 to +70 °C
Climatic conditions	Rel. humidity < 90 % annual average, without condensation
Site altitude	Up to 2000 m above sea level

**JUMO GmbH & Co. KG**

Delivery address: Mackenrodtstraße 14  
36039 Fulda, Germany  
Postal address: 36035 Fulda, Germany  
Phone: +49 661 6003-0  
Fax: +49 661 6003-607  
E-mail: mail@jumo.net  
Internet: www.jumo.net

**JUMO Instrument Co. Ltd.**

JUMO House  
Temple Bank, Riverway  
Harlow, Essex CM20 2DY, UK  
Phone: +44 1279 635533  
Fax: +44 1279 635262  
E-mail: sales@jumo.co.uk  
Internet: www.jumo.co.uk

**JUMO Process Control, Inc.**

6733 Myers Road  
East Syracuse, NY 13057, USA  
Phone: 315-437-5866  
1-800-554-5866  
Fax: 315-437-5860  
E-mail: info.us@jumo.net  
Internet: www.jumousa.com

**Interface**

Interface type	RS485
Protocol	Modbus RTU
Baud rate	9600, 19200
Data format	8 data bits, no parity bit, 1 stop bit
Device address	0 to 254
No. of subscribers	Max. 32

**7-segment displays**

Digit height	
LC100, LC200	Upper display: 10 mm; lower display: 7 mm
LC300	Upper display: 20 mm; lower display: 13 mm
Color	Upper display: red; lower display: green
Places	4 (including decimal places)
Decimal places	0, 1, 2 (configurable)
Display range	-1999 to 9999

**Approvals/approval marks**

Approval mark	Testing agency	Certificate/certification number	Inspection basis	Valid for
c UL us	Underwriters Laboratories	Submitted	UL 61010-1, CAN/CSA C22.2 No. 61010-1	all versions

**JUMO GmbH & Co. KG**  
 Delivery address: Mackenrodtstraße 14  
 36039 Fulda, Germany  
 Postal address: 36035 Fulda, Germany  
 Phone: +49 661 6003-0  
 Fax: +49 661 6003-607  
 E-mail: mail@jumo.net  
 Internet: www.jumo.net

**JUMO Instrument Co. Ltd.**  
 JUMO House  
 Temple Bank, Riverway  
 Harlow, Essex CM20 2DY, UK  
 Phone: +44 1279 635533  
 Fax: +44 1279 635262  
 E-mail: sales@jumo.co.uk  
 Internet: www.jumo.co.uk

**JUMO Process Control, Inc.**  
 6733 Myers Road  
 East Syracuse, NY 13057, USA  
 Phone: 315-437-5866  
 1-800-554-5866  
 Fax: 315-437-5860  
 E-mail: info.us@jumo.net  
 Internet: www.jumousa.com



# Dimensions

## LC100

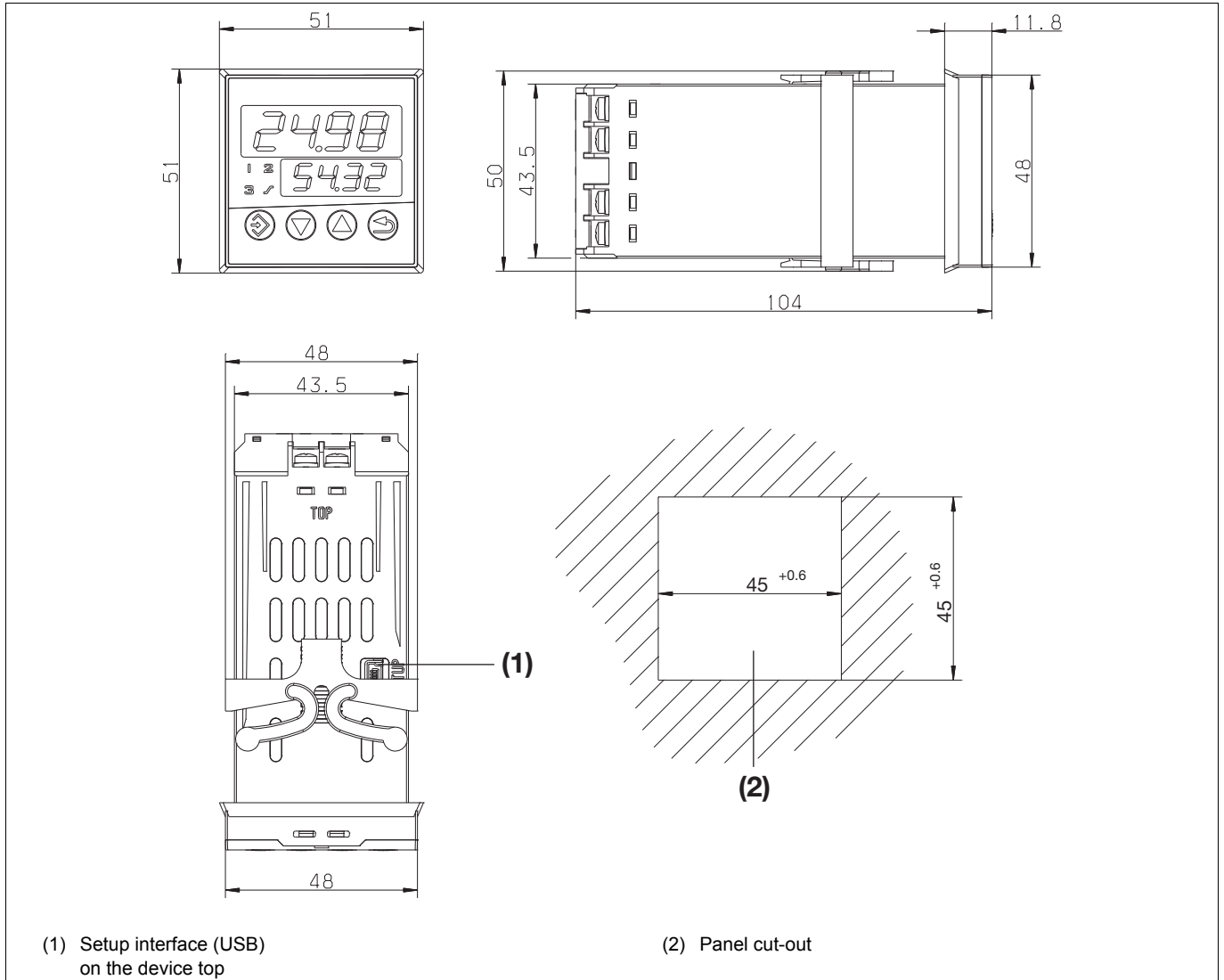

**JUMO GmbH & Co. KG**

Delivery address: Mackenrodtstraße 14  
36039 Fulda, Germany  
Postal address: 36035 Fulda, Germany  
Phone: +49 661 6003-0  
Fax: +49 661 6003-607  
E-mail: mail@jumo.net  
Internet: www.jumo.net

**JUMO Instrument Co. Ltd.**

JUMO House  
Temple Bank, Riverway  
Harlow, Essex CM20 2DY, UK  
Phone: +44 1279 635533  
Fax: +44 1279 635262  
E-mail: sales@jumo.co.uk  
Internet: www.jumo.co.uk

**JUMO Process Control, Inc.**

6733 Myers Road  
East Syracuse, NY 13057, USA  
Phone: 315-437-5866  
1-800-554-5866  
Fax: 315-437-5860  
E-mail: info.us@jumo.net  
Internet: www.jumousa.com



**LC200**

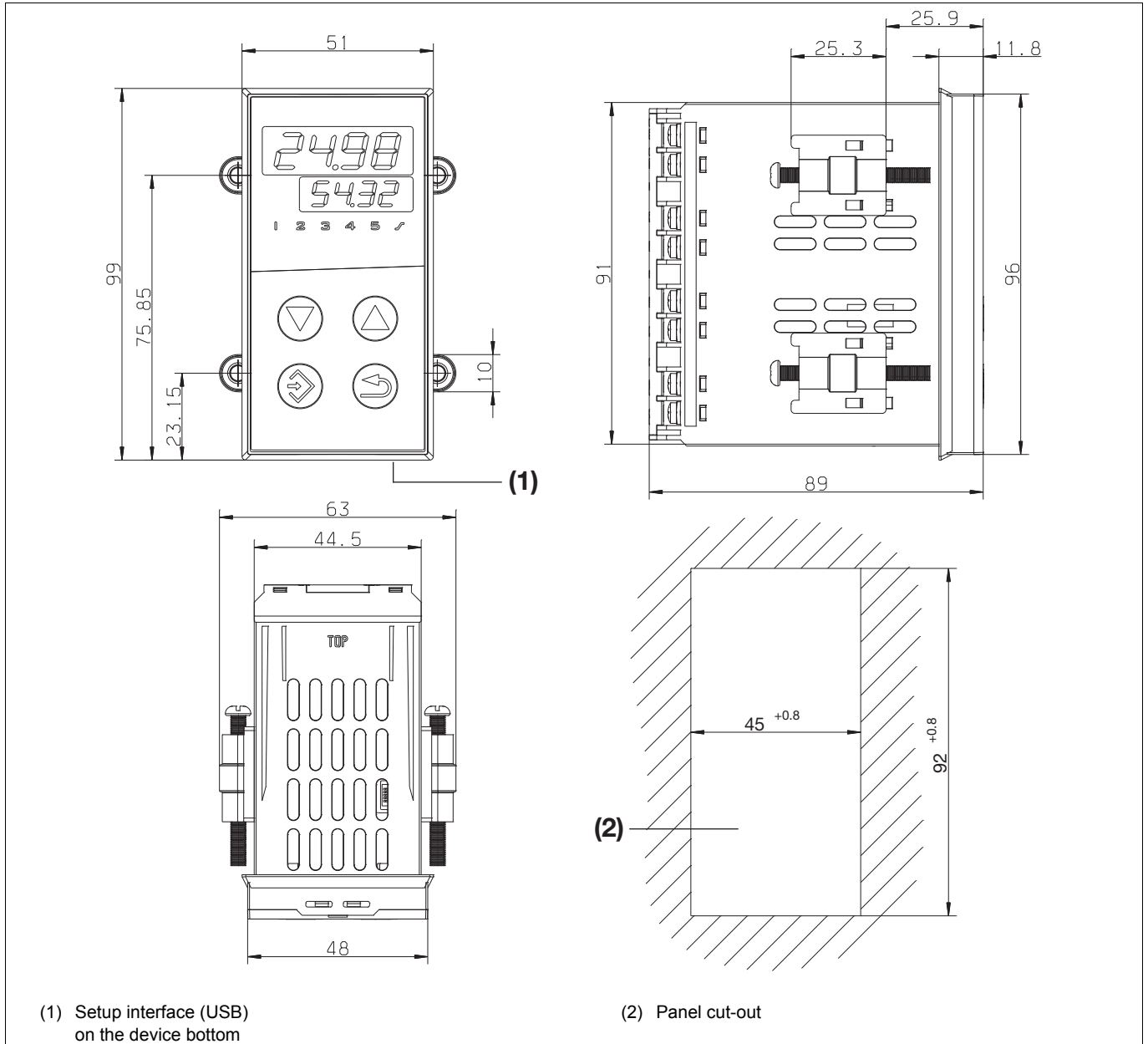



**JUMO GmbH & Co. KG**  
 Delivery address: Mackenrodtstraße 14  
 36039 Fulda, Germany  
 Postal address: 36035 Fulda, Germany  
 Phone: +49 661 6003-0  
 Fax: +49 661 6003-607  
 E-mail: mail@jumo.net  
 Internet: www.jumo.net

**JUMO Instrument Co. Ltd.**  
 JUMO House  
 Temple Bank, Riverway  
 Harlow, Essex CM20 2DY, UK  
 Phone: +44 1279 635533  
 Fax: +44 1279 635262  
 E-mail: sales@jumo.co.uk  
 Internet: www.jumo.co.uk

**JUMO Process Control, Inc.**  
 6733 Myers Road  
 East Syracuse, NY 13057, USA  
 Phone: 315-437-5866  
 1-800-554-5866  
 Fax: 315-437-5860  
 E-mail: info.us@jumo.net  
 Internet: www.jumousa.com



**LC300**

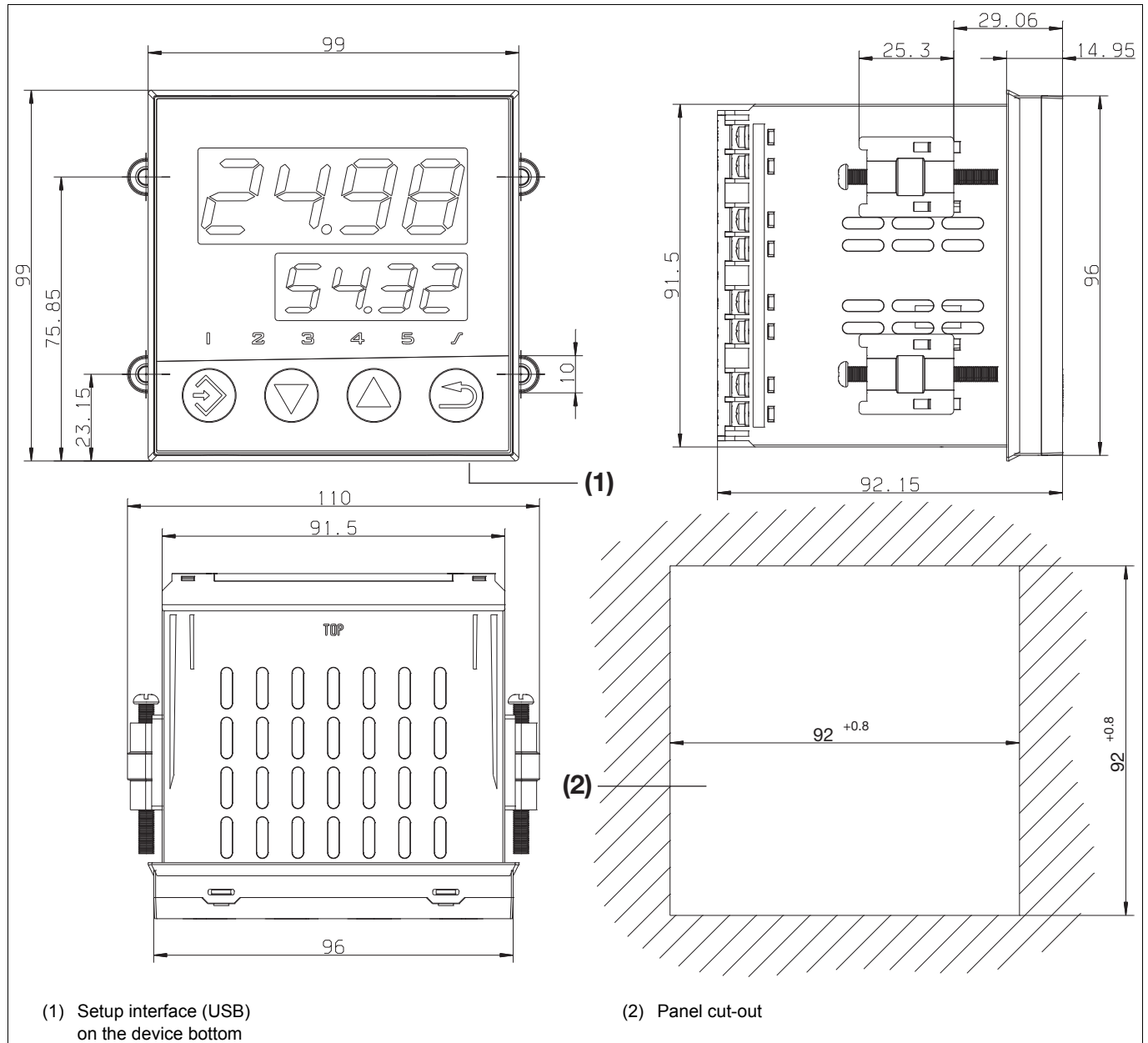

**Minimum spacing of panel cut-outs**

Type	Without USB cable		With USB cable	
	Horizontal	Vertical	Horizontal	Vertical
LC100	11 mm	30 mm	11 mm	65 mm
LC200	22 mm	30 mm	22 mm	65 mm
LC300	22 mm	30 mm	22 mm	65 mm



## Display and control elements

(A)	Programming / one level deeper
(B)	Value reduction / previous parameter
(C)	Value increase / next parameter
(D)	Function key / leave level
(E)	Red 7-segment display (factory-set: actual value); 4-digit, configurable decimal place (automatic adjustment on display overflow)
(F)	Green 7-segment display (factory-set: setpoint value); 4-digit, configurable decimal place; also display of level and parameter symbols
(G)	LED 1 to 3(5): switching position of binary output (LED is lit = output active)
(H)	LED ramp function or firing curve

The software version is displayed on the device when simultaneously pressing keys (A) and (C).

## Electrical isolation

(1)	Analog input
(2)	Binary input
(3)	(5) Setup interface (USB)
(4)	Voltage supply
(5)	RS485 interface
(6)	Analog output
(7)	Relay outputs
(8)	Logic outputs

## Connection diagram

The connection diagram in the data sheet provides preliminary information about the connection possibilities. For the electrical connection only use the brief instructions or the operating manual. The knowledge and the correct technical execution of the safety information/instructions contained in these documents are mandatory for installation, electrical connection, and startup as well as for safety during operation.

The terminal strips on the device rear are equipped with screw terminals. Please refer to the technical data for specifications concerning the conductor cross section.

LC100	LC200	LC300

**JUMO GmbH & Co. KG**  
 Delivery address: Mackenrodtstraße 14  
 36039 Fulda, Germany  
 Postal address: 36035 Fulda, Germany  
 Phone: +49 661 6003-0  
 Fax: +49 661 6003-607  
 E-mail: mail@jumo.net  
 Internet: www.jumo.net

**JUMO Instrument Co. Ltd.**  
 JUMO House  
 Temple Bank, Riverway  
 Harlow, Essex CM20 2DY, UK  
 Phone: +44 1279 635533  
 Fax: +44 1279 635262  
 E-mail: sales@jumo.co.uk  
 Internet: www.jumo.co.uk

**JUMO Process Control, Inc.**  
 6733 Myers Road  
 East Syracuse, NY 13057, USA  
 Phone: 315-437-5866  
 1-800-554-5866  
 Fax: 315-437-5860  
 E-mail: info.us@jumo.net  
 Internet: www.jumousa.com



Connection	Symbol	LC100	LC200/LC300
<b>Analog input</b>			
Thermocouple		9 8	10 11
RTD temperature probe, 2-wire		10 8	9 11
RTD temperature probe, 3-wire		10 9 8	9 10 11
Voltage DC 0 to 10 V (usable alternatively to binary input)		12 11	7 8
Current DC 0(4) to 20 mA		9 8	10 11
<b>Binary input</b> for potential-free contact (usable alternatively to analog input DC 0 to 10 V)		11 12	7 8
		<b>Output:</b>	<b>1 2 3 4 5</b>
<b>Analog output</b> DC 0 to 10 V, DC 0(4) to 20 mA		13 14	12 13
<b>Relay output</b> (N/O contact) (max. 3 A at AC 230 V, resistive load)		4 13 6 5 14 7	4 12 14 16 18 5 13 15 17 19
<b>Logic output</b> (DC 0/14 V)		13 7 14 6	12 14 16 18 13 15 17 19
<b>RS485 interface</b>		7 6	14 15
Output 1 as standard; outputs 2 to 5 optional (options 1 to 4)			
<b>Voltage supply</b>		L1 (L+) N (L-)	L1 (L+) N (L-)
<b>Setup interface</b>	USB socket, type Mini-B 5-pole		

**JUMO GmbH & Co. KG**  
 Delivery address: Mackenrodtstraße 14  
 36039 Fulda, Germany  
 Postal address: 36035 Fulda, Germany  
 Phone: +49 661 6003-0  
 Fax: +49 661 6003-607  
 E-mail: mail@jumo.net  
 Internet: www.jumo.net

**JUMO Instrument Co. Ltd.**  
 JUMO House  
 Temple Bank, Riverway  
 Harlow, Essex CM20 2DY, UK  
 Phone: +44 1279 635533  
 Fax: +44 1279 635262  
 E-mail: sales@jumo.co.uk  
 Internet: www.jumo.co.uk

**JUMO Process Control, Inc.**  
 6733 Myers Road  
 East Syracuse, NY 13057, USA  
 Phone: 315-437-5866  
 1-800-554-5866  
 Fax: 315-437-5860  
 E-mail: info.us@jumo.net  
 Internet: www.jumousa.com



## Order details

		<b>(1) Basic type</b>	
		702031	Quantrol LC100 (format 48 mm x 48 mm) 1x analog input (universal), 1x binary input <sup>a</sup> , 1x relay output (N/O contact)
		702032	Quantrol LC200 (format 48 mm x 96 mm, portrait format) 1x analog input (universal), 1x binary input <sup>a</sup> , 1x relay output (N/O contact)
		702034	Quantrol LC300 (format 96 mm x 96 mm) 1x analog input (universal), 1x binary input <sup>a</sup> , 1x relay output (N/O contact)
		<b>(2) Version</b>	
X	X	X	8 Standard with factory settings
X	X	X	9 Customer-specific configuration (specifications in plain text)
		<b>(3) Option for expansion slot 1</b>	
X	X	X	0 Not used
X	X	X	1 1 relay output (N/O contact)
X	X	X	2 1 logic output
X	X	X	3 1 analog output (configurable)
		<b>(4) Option for expansion slot 2</b>	
X	X	X	0 Not used
X	X	X	1 1 relay output (N/O contact)
X	X	X	2 1 logic output
X	X	X	4 1 RS485 interface
		<b>(5) Option for expansion slot 3</b>	
X	X	X	0 Not used
	X	X	1 1 relay output (N/O contact)
	X	X	2 1 logic output
		<b>(6) Option for expansion slot 4</b>	
X	X	X	0 Not used
	X	X	1 1 relay output (N/O contact)
	X	X	2 1 logic output
		<b>(7) Voltage supply</b>	
X	X	X	23 AC 110 to 240 V +10/-15 %, 48 to 63 Hz
X	X	X	25 AC/DC 20 to 30 V, 48 to 63 Hz

<sup>a</sup> Binary input for potential-free contact (usable alternatively to analog input DC 0 to 10 V).

<b>Order code</b>	(1)	(2)	(3)	(4)	(5)	(6)	(7)			
<b>Order example</b>	702034	/	8	-	3	4	1	2	-	23

## Scope of delivery

1 controller in the ordered version (including seal and fastening elements)
1 Brief Instructions B 702030.7 in DIN A6 format (multilingual)

## Accessories

Description	Part no.
USB cable, A-connector to Mini-B-connector, length 3 m	00506252